

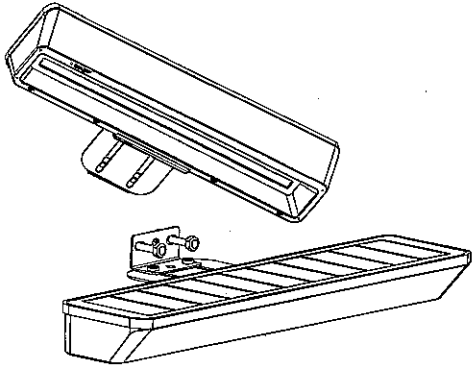

# User Manual

## SOLAR SIGNBOARD LED LIGHT



Please charge the Glowlite under strong sunlight before installation.  
Read and follow the instructions in this manual carefully before use.



### STEPS

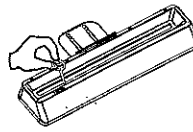

Step 1: Use a pin key to activate the Glowlite.

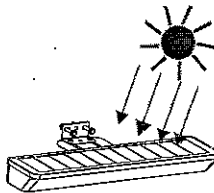

Step 2: The Glowlite will automatically switch OFF during daytime

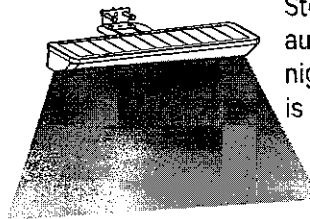

Step 3: The Glowlite will automatically switch ON at nightfall (or when ambient light is lower than 20lux)

### PRODUCT DIAGRAM

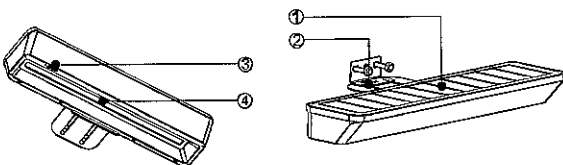

② Fixing Bracket

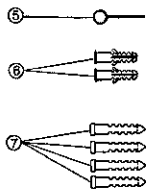
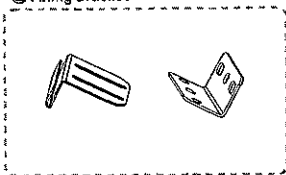

- ① Solar Panel      ② Fixing Bracket      ③ ON/OFF
- ④ LEDs            ⑤ PIN                    ⑥ Wall Anchor      ⑦ Screws

#### Specifications

|             |                     |                |                   |
|-------------|---------------------|----------------|-------------------|
| Solar Panel | 4W                  | Lighting Color | Lighting mode     |
| Battery     | Rechargeable Li-ion | ○ White        | Constant lighting |
| LEDs        | 160lum/W            | ○ Warm White   |                   |

#### APPLICATIONS

For mailboxes, signboards, signposts, fences, walls, etc.

### MODES OF INSTALLATION

Mode A: Wall Mounted

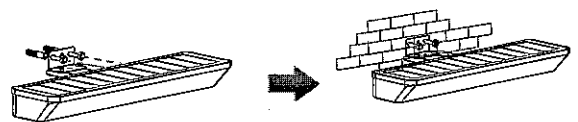

Mode B: Billboard mounted

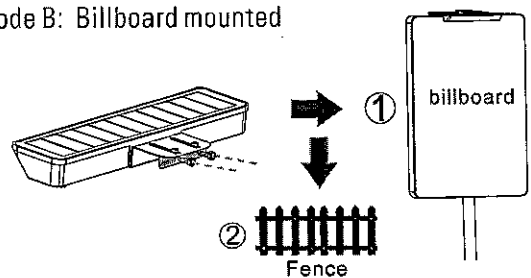

### NOTICE

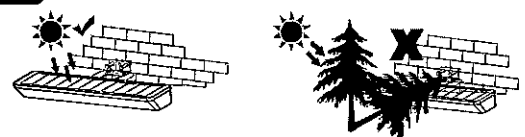

Make sure that the Glowlite's exposure is not obstructed by natural obstacles, like trees, buildings, etc.